

TECHNISCHE INFORMATIONEN

Balgen :	0.5 Faltenbalg
Breite :	60mm
Federweg :	6mm
Form :	Oval
Höhe :	31
Horizontalkraft :	300N
Kategorie :	Ovale
Länge :	124mm
Rohrinnendurchmesser :	AG G3/8"
Serie :	4RP
Sortiment :	Sauggreifer
Vertikalkraft :	150N

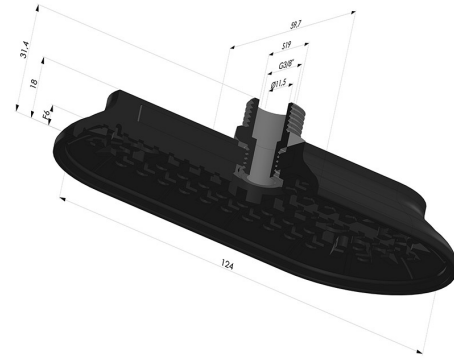

Varianten:



Variantenreferenz:

4RP 122NI M38

- Materiale: Nitril
- Shore-Härte: SH70