

TECHNISCHE INFORMATIONEN

Balgen :	0.5 Faltenbalg
Breite :	16mm
Federweg :	3mm
Form :	Oval
Höhe :	33
Horizontalkraft :	40N
Kategorie :	Ovale
Länge :	50mm
Rohrinnendurchmesser :	AG G3/8"
Serie :	4RP
Sortiment :	Sauggreifer
Vertikalkraft :	20N

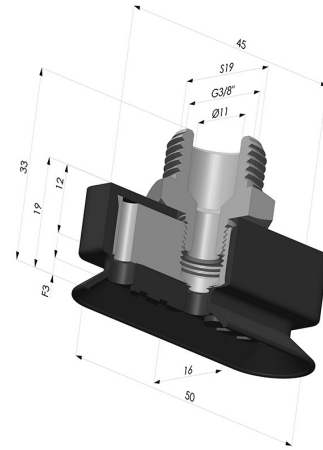

Varianten:

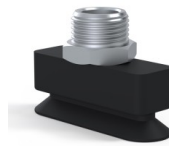

Variantenreferenz:

4RP 52NI M38

- Materiale: Nitril
- Shore-Härte: SH70