

TECHNICAL INFORMATION

Arrow :	16 mm
Category :	With bellows
Contact lip diameter :	75 mm
Height (in mm) :	31
Horizontal force :	200 N
inner barrel diameter :	G1/4
Number of bellows :	1.5 Bellows
Range :	Suction cup
Series :	8SB
Shape :	1.5 Bellows
Vertical force :	100 N

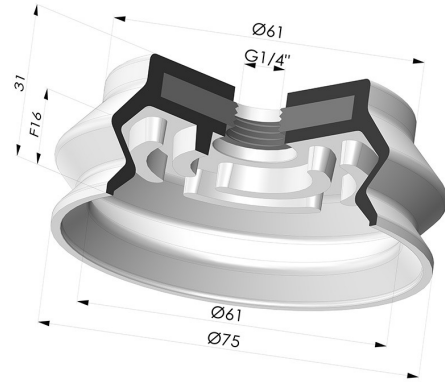

Variants:



Variant reference:

8SB 75SLT A

- Color: Translucent
- CE food certified
- Matter: Silicone
- Shore Hardness: SH60



Variant reference:

8SB 75NI A

- Color: Black
- Matter: Nitrile
- Shore Hardness: SH50