

**TECHNICAL INFORMATION**

<b>Arrow :</b>	16 mm
<b>Category :</b>	With bellows
<b>Contact lip diameter :</b>	75 mm
<b>Height (in mm) :</b>	45
<b>Horizontal force :</b>	200 N
<b>inner barrel diameter :</b>	Male G3/8"
<b>Number of bellows :</b>	1.5 Bellows
<b>Range :</b>	Suction cup
<b>Series :</b>	8SB
<b>Shape :</b>	1.5 Bellows
<b>Vertical force :</b>	100 N

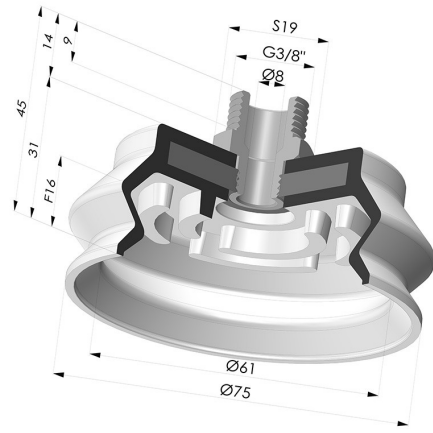

**Variants:**



Variant reference:  
**8SB 75SLT M38**

- Color: Translucent
- CE food certified
- Matter: Silicone
- Shore Hardness: SH60



Variant reference:  
**8SB 75NI M38**

- Color: Black
- Matter: Nitrile
- Shore Hardness: SH50