

TECHNICAL INFORMATION

Arrow :	22 mm
Category :	With bellows
Contact lip diameter :	41 mm
Height (in mm) :	46
Horizontal force :	56.5 N
inner barrel diameter :	7 mm
Mass :	18.5 g
Number of bellows :	2.5 Bellows
Range :	Suction cup
Series :	2
Shape :	2.5 Bellows
Vertical force :	28.3 N
Volume :	19.65 cm ³

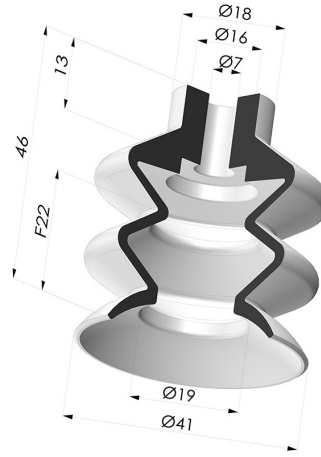

Variants:



Variant reference:
2 41MNT A

- Color: Bordeaux
- Matter: Non-staining material
- Shore Hardness: SH60



Variant reference:
2 41PU A

- Color: Blue
- Matter: Polyurethane
- Shore Hardness: SH60



Variant reference:
2 41SL A

- Color: Red food-grade CE certification
- Matter: Silicone
- Shore Hardness: SH60



Variant reference:
2 41SLT A

- Color: Translucent
- CE food certified
- Matter: Silicone
- Shore Hardness: SH60



Variant reference:
2 41NI A

- Color: Black
- Matter: Nitrile
- Shore Hardness: SH50

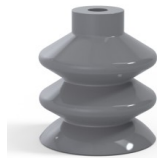

Variant reference:
2 41NR A

- Color: Gray
- Matter: Natural rubber
- Shore Hardness: SH50

Related products:

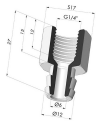

Separable Female Fitting G1/4"

Product reference: D



Separable Male Fitting G1/4"

Product reference: E

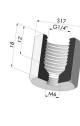

Adaptor - Female G1/4" - Female M6

Product reference: F14F6



Adaptor - Female 1/8G - Female M6

Product reference: F18F6

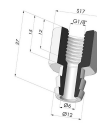

Separable Female Fitting G1/8"

Product reference: H

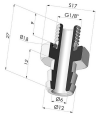

Separable Male Fitting G1/8"

Product reference: I



Crimped Female Fitting G1/4"

Product reference: L

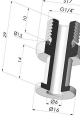

Crimped Male Fitting G1/4"

Product reference: M

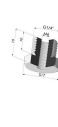

Adaptor - Male 1/4G - Female M6

Product reference: M14F6



Adaptor - Male 1/8G - Female M6

Product reference: M18F6



Screw M5 - Head Ø 14 mm - L 20.5 mm

Product reference: M5



Screw M6 - Head Ø 14 mm - L 20.5 mm

Product reference: M6



Crimped Female Fitting G1/8"

Product reference: R

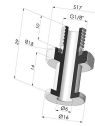

Crimped Male Fitting G1/8"

Product reference: S



Nut for suction cup 2 41

Product reference: ECR TAC 2 41



Screw M8 - Head Ø 14 mm - L 20 mm

Product reference: M8T14L20.5