

**TECHNICAL INFORMATION**

<b>Arrow :</b>	15 mm
<b>Category :</b>	With bellows
<b>Contact lip diameter :</b>	34 mm
<b>Height (in mm) :</b>	42
<b>Horizontal force :</b>	38 N
<b>inner barrel diameter :</b>	Male G3/8"
<b>Number of bellows :</b>	1.5 Bellows
<b>Range :</b>	Suction cup
<b>Series :</b>	91
<b>Shape :</b>	1.5 Bellows
<b>Vertical force :</b>	19 N

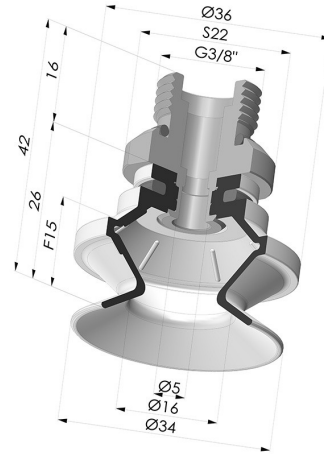

**Variants:**



Variant reference:  
**91 31NI 38D-2**  
 • Color: Black  
 • Matter: Nitrile



Variant reference:  
**91 31SL 38D-2**  
 • Color: Red food-grade CE certification  
 • Matter: Silicone  
 • Shore Hardness: SH60



Variant reference:  
**91 31SLT 38D-2**  
 • Color: Translucent  
 • CE food certified  
 • Matter: Silicone  
 • Shore Hardness: SH60

**Related products:**

**Bellows Suction Cup 1.5 folds Series 91, Ø 35 mm**  
 Product reference: 91 31-- A

**Separable Male Fitting 3/8G**  
 Product reference: 9M38-2