

INFORMACIÓN TÉCNICA

Altura (en mm) :	22.5
Categoría :	Fuelles
Diámetro del labio :	20 mm
Diámetro interior del cuello :	3.8 mm
Flecha :	10 mm
Forma :	2,5 Fuelles
Fuerza horizontal :	13.9 N
Fuerza vertical :	7 N
Gama :	Ventosa
Masa :	2.20 g
Número de fuelles :	2,5 fuelles
Serie :	2
Volumen :	1.87 cm ³

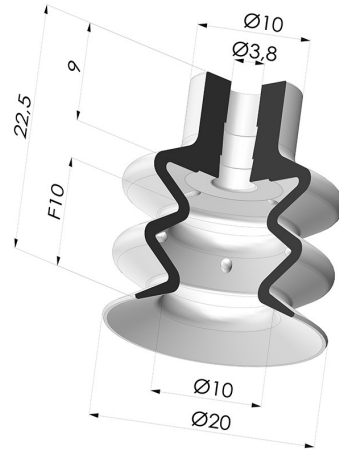

Variantes:

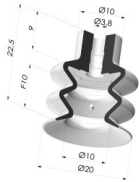

Referencia de la variante:

2 20MNT A

- Color: Borgoña
- Dureza Shore: SH60
- Materiales: Material antimanchas



Referencia de la variante:

2 20PU A

- Color: Azul
- Dureza Shore: SH60
- Materiales: Poliuretano



Referencia de la variante:

2 20SL A

- Color: Rojo certificación alimentaria CE
- Dureza Shore: SH60
- Materiales: Silicona



Referencia de la variante:

2 20SLT A

- Color: Translúcido certificación alimentaria CE
- Dureza Shore: SH60
- Materiales: Silicona



Referencia de la variante:

2 20SLV A

- Color: Verde certificación alimentaria CE
- Dureza Shore: SH60
- Materiales: Silicona



Referencia de la variante:

2 20SLBLEU A

- Color: Azul certificación alimentaria CE
- Dureza Shore: SH60
- Materiales: Silicona



Referencia de la variante:

2 20NI A

- Color: Negro
- Dureza Shore: SH50
- Materiales: Nitrilo



Referencia de la variante:

2 20NR A

- Color: Gris
- Dureza Shore: SH50
- Materiales: Caucho natural

















Referencia de la variante:

2 20SLBLEU A SH30





- Color: Azul certificación alimentaria CE
- Dureza Shore: SH30
- Materiales: Silicona

Guía de materiales:

Material	Código	Resistencia a temperatura (°C)	Flexibilidad	Resistencia a la abrasión	Resistencia UV/Intemperie	Resistencia a aceites	Compatibilidad alimentaria	Test de migración
----------	--------	--------------------------------	--------------	---------------------------	---------------------------	-----------------------	----------------------------	-------------------

	Material antimanchas Borgoña	MNT	-20/+160	✓	✓	✓✓✓	✓✓✓	✗	✗
	Poliuretano Azul	PU	-20/+80	✓	✓✓✓	✓✓	✓✓	✗	✗
	Silicona Rojo certificación alimentaria CE	SL	-60/+250	✓✓✓	✗	✓✓✓	✗		A, B, D2
	Silicona Translúcido certificación alimentaria CE	SLT	-60/+250	✓✓✓	✗	✓✓✓	✗		✗
	Silicona Verde certificación alimentaria CE	SLV	-60/+250	✓✓✓	✗	✓✓✓	✗		✗
	Silicona Azul certificación alimentaria CE	SLBLEU	-60/+250	✓✓✓	✗	✓✓✓	✗		A, B, D2
	Nitrilo Negro	NI	-10/+80	✓	✓	✗	✓✓	✗	✗
	Caucho natural Gris	NR	-20/+70	✓✓✓	✓✓	✗✗	✗✗	✗	✗
	Silicona Azul certificación alimentaria CE	SLBLEU	-60/+250	✓✓✓	✗	✓✓✓	✗		A, B, D2

Las solicitudes de certificados FDA y/o CE deben realizarse OBLIGATORIAMENTE en el momento del pedido. Una solicitud posterior conllevará costes adicionales. Para responder a las expectativas de nuestros clientes industriales, NOVACOM dispone del mayor abanico de materiales elastoméricos o termoplásticos. También podemos desarrollar nuevos materiales según un pliego de condiciones preciso, para resolver aplicaciones específicas de nuestros clientes.

 Excelente |
  Buena |
  Media |
  Baja |
  No recomendado
 *Es posible solicitar certificado FDA y/o CE en diversas referencias en el momento del pedido; consúltenos.
 ** Certificación de contacto alimentario: (CE) 1935/2004 - (FDA) 21 CFR 177.2600
 *** Certificación de contacto alimentario: (CE) 10/2011 - (FDA) 21 CFR

Productos relacionados:

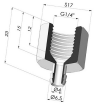

Conexión Desmontable Hembra G1/4"

Referencia del
producto: B



Conexión Desmontable Macho G1/4"

Referencia del
producto: C



Conexión Desmontable Hembra G1/8"

Referencia del
producto: F

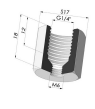

Adaptador - Hembra G1/4" - Hembra M6

Referencia del
producto: F14F6



Adaptador - Hembra G1/8" - Hembra M6

Referencia del
producto: F18F6



Conexión Desmontable Macho G1/8"

Referencia del
producto: G



Adaptador - Macho 1/4G - Hembra M6

Referencia del
producto: M14F6



Adaptador - Macho 1/8G - Hembra M6

Referencia del
producto: M18F6



Inserto Desmontable Macho M5

Referencia del
producto: M5C11



Inserto Desmontable Macho M6

Referencia del
producto: M6C



Inserto Desmontable Macho M5

Referencia del
producto: M5C --