

INFORMAZIONI TECNICHE

- Altezza (in mm) :** 16
Categoria : A soffiatti
Corsa : 6.5 mm
Diametro del collo interno : 4 mm
Diametro labbro : 19.7 mm
Forma : 1,5 soffiatti
Forza orizzontale : 14 N
Forza verticale : 7 N
Gamma : Ventosa
Massa : 1.60 g
Numero di soffiatti : 1,5 soffiatti
Serie : 1
Volume : 0.97 cm³

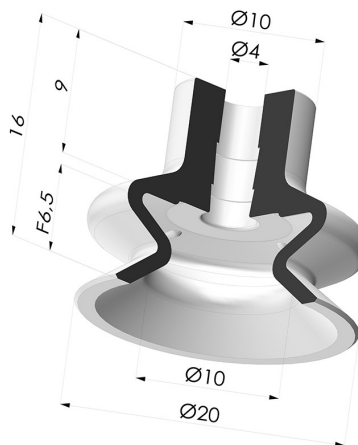

Varianti:



Riferimento variante:

1 20MNT A

- Colore: Bordeaux
- Durezza Shore: SH 60
- Materiale: Antialone



Riferimento variante:

1 20PU A

- Colore: Blu
- Durezza Shore: SH 60
- Materiale: Poliuretano



Riferimento variante:

1 20SL A

- Colore: Rosso Certificato alimentare CE
- Durezza Shore: SH 60
- Materiale: Silicone



Riferimento variante:

1 20SLT A

- Colore: Trasparente Certificato alimentare CE
- Durezza Shore: SH 60
- Materiale: Silicone



Riferimento variante:

1 20SLV A

- Colore: Verde Certificato alimentare CE
- Durezza Shore: SH 60
- Materiale: Silicone



Riferimento variante:

1 20NI A

- Colore: Nero
- Durezza Shore: SH50
- Materiale: Nitrile









Riferimento variante:

1 20NR A

- Colore: Grigio
- Durezza Shore: SH50
- Materiale: Gomma naturale

Guida ai materiali:

	Materiale	Codice	Resistenza temperatura (°C)	Flessibilità	Resistenza abrasione	Resistenza UV/Intemperie	Resistenza oli	Compatibilità alimentare	Test di migrazione
	Antialone Bordeaux	MNT	-20/+160	✓	✓	✓✓✓	✓✓✓	✗	✗
	Poliuretano Blu	PU	-20/+80	✓	✓✓✓	✓✓	✓✓	✗	✗
	Silicone Rosso Certificato alimentare CE	SL	-60/+250	✓✓✓	✗	✓✓✓	✗	FDA ☞☞	A, B, D2

	Silicone Trasparente Certificato alimentare CE	SLT	-60/+250	✓✓✓	✗	✓✓✓	✗	FDA 	✗
	Silicone Verde Certificato alimentare CE	SLV	-60/+250	✓✓✓	✗	✓✓✓	✗	FDA 	✗
	Nitrile Nero	NI	-10/+80	✓	✓	✗	✓✓	✗	✗
	Gomma naturale Grigio	NR	-20/+70	✓✓✓	✓✓	✗✗	✗✗	✗	✗

Le richieste di certificati FDA e/o CE devono essere effettuate OBBLIGATORIAMENTE al momento dell'ordine. Una richiesta successiva comporterà costi aggiuntivi. Per soddisfare le aspettative dei nostri clienti industriali, NOVACOM dispone della più ampia gamma di materiali elastomerici o termoplastici. Possiamo inoltre sviluppare nuovi materiali secondo un capitolato tecnico preciso, al fine di risolvere applicazioni specifiche per i nostri clienti.

 Eccellente |
  Buona |
  Media |
  Bassa |
  Non raccomandato
 *È possibile richiedere un certificato FDA e/o CE su diverse referenze al momento dell'ordine; contattateci.
 ** Certificazione per contatto alimentare: (CE) 1935/2004 - (FDA) 21 CFR 177.2600
 *** Certificazione per contatto alimentare: (CE) 10/2011 - (FDA) 21 CFR

Prodotti correlati:



Ventosa 1.5 Soffietti Serie 1 Ø 20MM - a sganciamento
Riferimento prodotto: 120-- A SPD



Inserto a resca Femmina G1/4"
Riferimento prodotto: B



Inserto a resca Maschio G1/4"
Riferimento prodotto: C



Inserto a resca Femmina G1/8"
Riferimento prodotto: F



Adattatore - Femmina G1/4" - Femmina M6
Riferimento prodotto: F14F6



Adattatore - Femmina G1/8" - Femmina M6
Riferimento prodotto: F18F6



Inserto a resca Maschio G1/8"
Riferimento prodotto: G



Adattatore - Maschio G1/8" - Femmina G1/8"
Riferimento prodotto: M14F6



Adattatore - Maschio G1/8" - Femmina M6
Riferimento prodotto: M18F6



Inserto a resca Maschio M5
Riferimento prodotto: M5C11



Inserto a resca Maschio M6
Riferimento prodotto: M6C



Inserto a resca Maschio M5
Riferimento prodotto: M5C --