

INFORMAZIONI TECNICHE

Altezza (in mm) : 33.5
Categoria : A soffiatti
Corsa : 14 mm
Diametro del collo interno : 8 mm
Diametro labbro : 52 mm
Forma : 1,5 soffiatti
Forza orizzontale : 94 N
Forza verticale : 47 N
Gamma : Ventosa
Massa : 15 g
Numero di soffiatti : 1,5 soffiatti
Serie : 1
Volume : 24.18 cm³

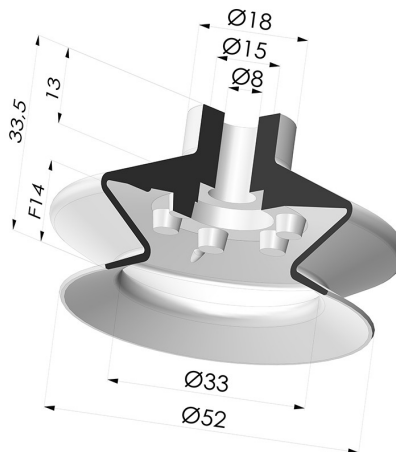

Varianti:



Riferimento variante:
1 53MNT A

- Colore: Bordeaux
- Durezza Shore: SH 60
- Materiale: Antialone



Riferimento variante:
1 53PU A

- Colore: Blu
- Durezza Shore: SH 60
- Materiale: Poliuretano



Riferimento variante:
1 53SLT A

- Colore: Trasparente
- Certificato alimentare CE
- Durezza Shore: SH 60
- Materiale: Silicone



Riferimento variante:
1 53NI A

- Colore: Nero
- Durezza Shore: SH50
- Materiale: Nitrile

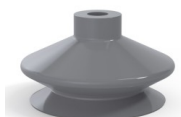

Riferimento variante:
1 53NR A

- Colore: Grigio
- Durezza Shore: SH50
- Materiale: Gomma naturale



Riferimento variante:
1 53TPE A

- Colore: Trasparente
- Certificato alimentare CE
- Durezza Shore: SH50
- Materiale: Termoplastica

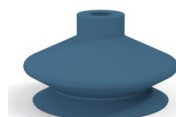

Riferimento variante:
1 53SLDB A

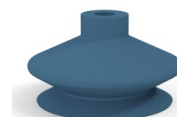

- Colore: Blu Certificato alimentare CE
- Durezza Shore: SH40
- Materiale: Silicone rilevabile







Riferimento variante:
1 53SLDB A SH60





- Colore: Blu Certificato alimentare CE
- Durezza Shore: SH 60
- Materiale: Silicone rilevabile

Guida ai materiali:









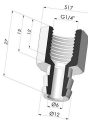
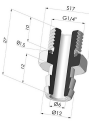
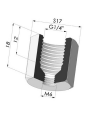

	Materiale	Codice	Resistenza temperatura (°C)	Flessibilità	Resistenza abrasione	Resistenza UV/Intemperie	Resistenza oli	Compatibilità alimentare	Test di migrazione
	Antialone Bordeaux	MNT	-20/+160	✓	✓	✓✓✓	✓✓✓	✗	✗
	Poliuretano Blu	PU	-20/+80	✓	✓✓✓	✓✓	✓✓	✗	✗
	Silicone Trasparente Certificato alimentare CE	SLT	-60/+250	✓✓✓	✗	✓✓✓	✗	FDA ☞☞	✗

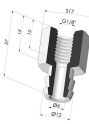
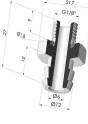
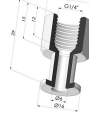
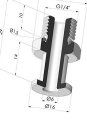
	Nitrile Nero	NI	-10/+80	✓	✓	✗	✓✓	✗	✗
	Gomma naturale Grigio	NR	-20/+70	✓✓✓	✓✓	✗✗	✗✗	✗	✗
	Silicone rilevabile Blu Certificato alimentare CE	SLDB	-60/+250	✓✓✓	✗	✓✓✓	✗	FDA ☞☞	A, B, D2
	Silicone rilevabile Blu Certificato alimentare CE	SLDB	-60/+250	✓✓✓	✗	✓✓✓	✗	FDA ☞☞	A, B, D2

Le richieste di certificati FDA e/o CE devono essere effettuate OBBLIGATORIAMENTE al momento dell'ordine. Una richiesta successiva comporterà costi aggiuntivi. Per soddisfare le aspettative dei nostri clienti industriali, NOVACOM dispone della più ampia gamma di materiali elastomerici o termoplastici. Possiamo inoltre sviluppare nuovi materiali secondo un capitolato tecnico preciso, al fine di risolvere applicazioni specifiche per i nostri clienti.

 Eccellente |
  Buona |
  Media |
  Bassa |
  Non raccomandato
 *È possibile richiedere un certificato FDA e/o CE su diverse referenze al momento dell'ordine; contattateci.
 ** Certificazione per contatto alimentare: (CE) 1935/2004 - (FDA) 21 CFR 177.2600
 *** Certificazione per contatto alimentare: (CE) 10/2011 - (FDA) 21 CFR

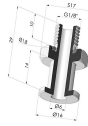
Prodotti correlati:

 Inserto a resca Femmina G1/4" Riferimento prodotto: D	 Inserto a resca Maschio G1/4" Riferimento prodotto: E	 Adattatore - Femmina G1/4" - Femmina M6 Riferimento prodotto: F14F6	 Adattatore - Femmina G1/8" - Femmina M6 Riferimento prodotto: F18F6	 Inserto a resca Femmina G1/8" Riferimento prodotto: H
 Inserto a resca Maschio G1/8" Riferimento prodotto: I	 Inserto Rivettato Femmina G1/4" Riferimento prodotto: L	 Inserto Rivettato Maschio G1/4" Riferimento prodotto: M	 Adattatore - Maschio G1/8" - Femmina G1/8" Riferimento prodotto: M14F6	 Adattatore - Maschio G1/8" - Femmina M6 Riferimento prodotto: M18F6
 Vite M5 - ØTesta 14MM - L 20.5MM Riferimento prodotto: M5	 Vite M6 - ØTesta 14MM - L 20.5MM Riferimento prodotto: M6	 Inserto Rivettato Femmina G1/8" Riferimento prodotto: R	 Inserto Rivettato Maschio G1/8" Riferimento prodotto: S	 Vite M8 - ØTesta 14MM - L 20MM Riferimento prodotto: M8T14L20.5